

Z●IN

Collection
2022

Our Expertise, Your Dream

OUR COMMITMENT

Z•IN

La nuova collezione Zoin, totalmente Made in Italy, offre una gamma completa di banchi a “Servizio Assistito” e “Self Service” affidabili a prezzi competitivi.

Ogni giorno, con i nostri prodotti, soddisfiamo i diversi linguaggi delle tradizioni e culture etno-gastronomiche del nostro pianeta.

L’attenzione all’ambiente è un must per Zoin: l’intera gamma utilizza il refrigerante eco-friendly R290.

Zoin fa parte della *Famiglia Criocabin* rimanendo comunque una entità ed un marchio indipendente.

The new Zoin collection, 100% Made in Italy, offers a full range of reliable and value-for-money assisted service and self-service units. Every day our products meet the needs of a full plethora of our planet’s traditions and ethnic cuisines. Environmental protection is a priority for Zoin: the full range uses the eco-friendly coolant R290. Zoin is an independent brand and entity belonging to the Criocabin Family.

OUR PRODUCTS

Serve-Over Counter

PORTHOS	6
MESETAS	12
ORLEANS	18
KRISTALL	22
PATAGONIA	28
TIBET	34
SAIGON	40
MELODY	42
COLORADO	44
VR	48

Self Service Display

CHAMONIX	50
CERVINO	56
OLIMPO	62
SILVER	68
DANNY	70
MAUNA	72
FUJIYAMA	78
MANDY	82
FLATEY	84

OUR FUNCTIONALITY



Carne
Meat
Viande
Fleisch



Bevande
Drinks
Boissons
Getränke



Salumi - Formaggi
Sausages - Cheese
Charcuterie - Produits Laitiers
Wurstwaren - Milchprodukte

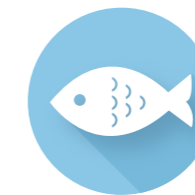

Pesce
Fish
Poisson
Fisch



Gastronomia
Deli
Deli
Deli



Frutta e Verdura
Fruits and Vegetables
Fruits et Legumes
Obst und Gemüse



Pasticceria
Pastry
Pâtisserie
Bäckerei



Sushi



Larghezza in cm.
Width in cm.
Largeur en cm.
Breite in cm.



Lunghezza in cm.
Length in cm.
Longueur en cm.
Länge in cm.

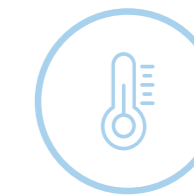

Classe climatica
Climate class
Classe climatique
Klima-Klasse



Profondità ripiano in cm.
Shelf Depth in cm.
Profondeur étagère en cm.
Regal-Tiefe in cm.



Capacità di carico in lt.
Load capacity in lt.
Capacité de charge en lt.
Tragfähigkeit in lt.

PORTHOS



Width in cm.

109



Length in cm.

150 · 200
250 · 300



Climate class

3 M2
25°C / u.r. 60%

Stile, efficienza e qualità costruttiva.

Lo stile modernamente curato e l'ampia gamma di versioni, accessori e possibilità di personalizzazioni lo rendono ideale per soddisfare ogni esigenza e ogni layout nei concept stores più alla moda.



Style, efficiency and quality of design.

With its search for modern design and wide range of versions, accessories and customization options, it is perfect to suit all the needs and layouts of modern concept stores.

Style, efficacité et qualité de construction.

Grâce à son style très actuel et à sa vaste gamme de versions, d'accessoires et de possibilités de personnalisation, il devient idéal pour satisfaire toutes les exigences et tous les concepts stores les plus branchés.

Stil, Effizienz und Verarbeitungsqualität.

Der moderne Stil und die große Vielfalt an Ausführungen, Zubehör und Anpassungsmöglichkeiten erlauben es, jeder Anforderung und jedem Layout in den angesagtesten Concept Stores gerecht zu werden.

D137 Urban Wood
Version
PL-1 / AA 90° / PC-5

PORTHOS

White Oak
Version
PL-1 / AA 90° / PC-5 **D136**



1

Vetri apribili verso l'alto.

Lift up glass structure.

Structure avec verre s'ouvrant vers le haut.

Hebenverglasung Struktur.

2

Robusta struttura in alluminio

Solid aluminium structure.

Structure robuste en aluminium.

Stabile Aluminium-Struktur.

3

Illuminazione LED.

LED lighting.

Éclairage LED

LED-Beleuchtung

4

Zona esposizione in acciaio Inox.

Display area in stainless steel.

Zone d'exposition en acier inox.

Auslagefläche aus Edelstahl.

5

Piano lavoro standard in acciaio Inox.

Standard working plate in stainless steel.

Plan de travail standard en acier inox.

Standard Arbeitsplatte aus Edelstahl.

D107

Splendido
Azzurro
PL-2 / Terminal Cash / PF-2



Merce facile da posizionare con vetri frontali apribili.

The glass opens from the front to facilitate the display of goods.

Marchandise facile à exposer avec vitres frontales ouvrables.

Leicht zu positionierende Waren dank aufklappbarer Frontfenster.



Versione PC5 – Riscaldamento Bagno Maria

Version PC5 – Bain Marie warming method.

Version PC5 – Chauffage au bain-marie.

Version PC5 – Warmhalten im Wasserbad.

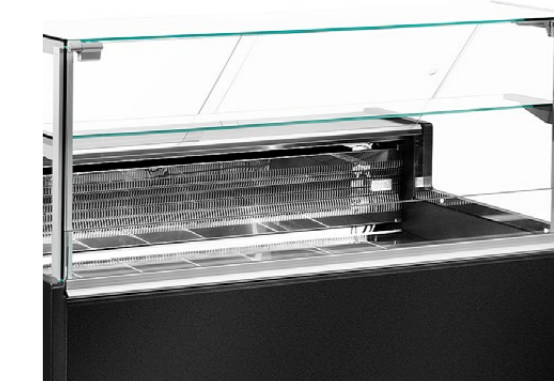

Vetro intermedio (optional con illuminazione a LED).

Intermediate glass (optional LED lighting).

Vitre intermédiaire (option avec éclairage à LED).

Zwischenregal aus Glas (optional mit LED-Beleuchtung).

PORTHOS Versions

Gray Black Optional

Colori spalla
End colours
Couleurs des côtés
Farben für Rückwände

PL-1

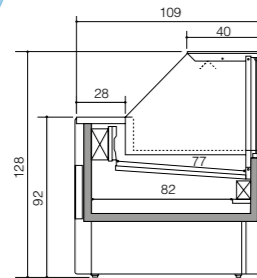

Statico con cella
Static with cool storage
Statique avec réserve
Statisch mit Unterbaukuehlung

PL-2

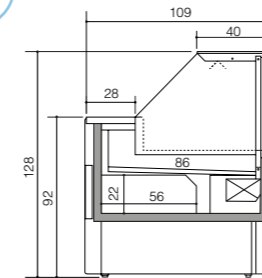

Ventilato con cella
Ventilated with cool storage
Ventiléé avec réserve
Umluft mit Unterbaukuehlung

PO-3

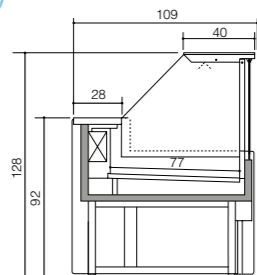

Statico senza cella
Static without cool storage
Statique sans réserve
Statisch ohne Unterbaukuehlung

PO-4

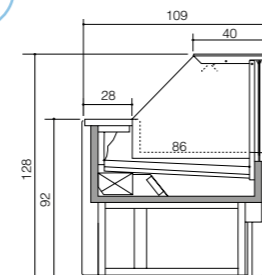

Ventilato senza cella
Ventilated without cool storage
Ventiléé sans réserve
Umluft ohne Unterbaukuehlung

PC-5

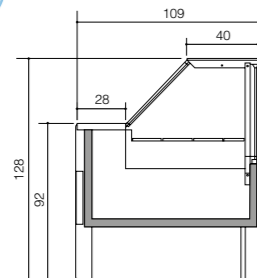

Riscaldamento - Bain-Maria
Heating - Bain Marie
Chauffage - Bain-Marie
Heisse Theke - Bain-Marie

PF-2

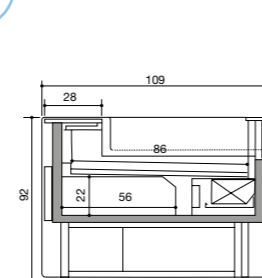

Self Service
Ventilato con cella
Ventilated with cool storage
Ventiléé avec réserve
Umluft mit Unterbaukuehlung

Cold? Hot? Well, both.



ZOIN



Width in cm.

98



Length in cm.

150 · 200
250 · 300
350 · 400



Climate class

3 M2
25°C / u.r. 60%

L'espositore alla moda per i locali più trendy.

Perfetto per creare ambienti di vendita dal gusto contemporaneo e internazionale, Mesetas si distingue per gli alti contenuti tecnici e per il design di successo. È particolarmente adatto agli ambienti in cui è necessario massimizzare lo spazio espositivo.

A trendy display counter for trendy stores.

Perfect to add a contemporary and international touch, Mesetas stands out for its successful design and high technological content. Specifically indicated where the display area needs to be maximised.

Le présentoir à la mode pour les commerces les plus branchés.

Parfait pour créer des espaces de vente au style contemporain et international, Mesetas est caractérisé par ses contenus techniques élevés et son design très apprécié. Il s'adapte particulièrement aux espaces dans lesquels il est primordial de maximiser la surface d'exposition.

Der modische Aussteller für die trendigsten Locations.

Mesetas eignet sich perfekt für die Kreation von Verkaufswelten mit einem zeitgemäßen und internationalen Geschmack. Es zeichnet sich durch einen hohen technischen Gehalt und ein gelungenes Design aus und eignet sich ganz besonders für Bereiche, in denen der Ausstellraum maximal ausgeschöpft werden soll.

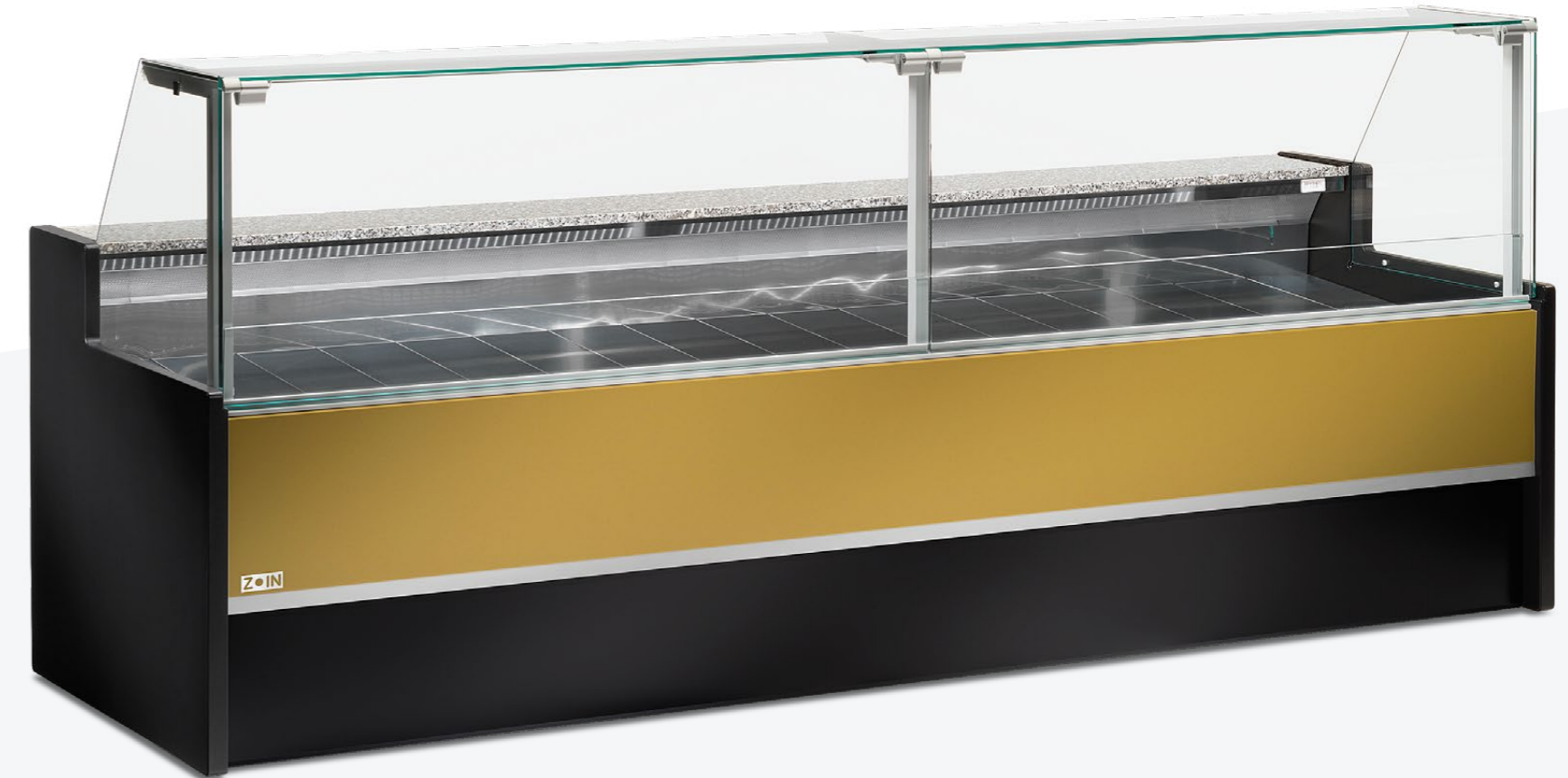

D153 Magic Gold Version D-2

MESETAS



1

Vetri apribili verso l'alto.

Lift up glass structure.

Structure avec verre s'ouvrant vers le haut.

Hebenverglasung Struktur.

2

Robusta struttura in alluminio.

Solid aluminium structure.

Structure robuste en aluminium.

Stabile Aluminium-Struktur.

3

Zona esposizione in acciaio Inox.

Display area in stainless steel.

Zone d'exposition en acier inox.

Auslagefläche aus Edelstahl.

4

Piano lavoro in granito (Rosa Beta).

Working plate in granit (Rosa Beta).

Plan de travail en granit (Rosa Beta).

Arbeitsplatte aus (Rosa Beta).

Tortora
Version
D-2

D152

I301
Scotch Brite
Version
C-2

I301

White Oak
Version
C-2

D136



Merce facile da posizionare con vetri frontali apribili.

The glass opens from the front to facilitate the display of goods.

Marchandise facile à exposer, grâce aux vitres frontales ouvrables.

Leicht zu positionierende Waren dank aufklappbarer Frontfenster.



Massima trasparenza.

Maximum transparency.

Transparence maximum.

Maximale Transparenz.



D2 Versione ventilata.

D2 ventilated version.

D2 Version ventilée.

D2 Belüftete Ausführung.

MESETAS Versions

Gray **Black** Optional

Colori spalla
End colours
Couleurs des côtés
Farben für Rückwände

C-1

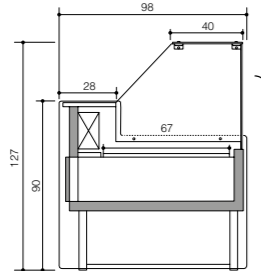

Vetri apribili a compasso -
Statico con cella

Glass with hinged opening -
Static with cool storage

Statique avec réserve -
Vitres relevables

Fenster mit Kompassöffnung -
Statisch mit Unterbaukuehlung

C-2

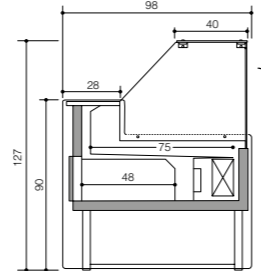

Vetri apribili a compasso -
Ventilato con cella

Glass with hinged opening -
Ventilated with cool storage

Ventiléé avec réserve -
Vitres relevables

Fenster mit Kompassöffnung -
Umluft mit Unterbaukuehlung

D-1

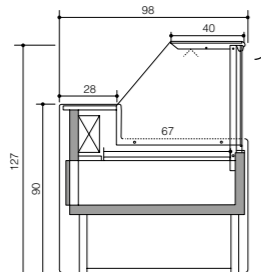

Vetri apribili verso l'alto -
Statico con cella

Lift up glass structure -
Static with cool storage

Structure avec verre s'ouvrant
vers le haut - Statique avec réserve

Hebenverglasung Struktur -
Statisch mit Unterbaukuehlung

D-2

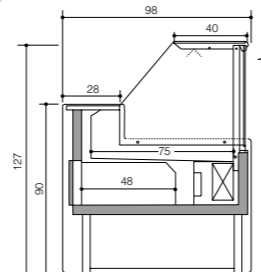

Vetri apribili verso l'alto -
Ventilato con cella

Lift up glass structure -
Ventilated with cool storage

Structure avec verre s'ouvrant
vers le haut - Ventiléé avec réserve

Hebenverglasung Struktur -
Umluft mit Unterbaukuehlung

Now, that's
a trendy counter!



ZOIN

ORLEANS



Width in cm.

81



Length in cm.

100 · 150
200 · 250



Climate class

3 M2
25°C / u.r. 60%

Un espositore dal design curato e attuale, da personalizzare per allinearlo allo stile del punto vendita.

Orleans è particolarmente indicato per pasticceria, pane, gastronomia, sandwich e in generale per negozi di piccole dimensioni: grazie alla sua larghezza di 81 cm può essere inserito in ambienti dallo spazio ridotto.

The search for contemporary design is what distinguishes this display, which can be customised according to the style of the store.

Orleans is specifically designed for pastry products, bread, gastronomy, sandwiches and for small stores. With a width of 81 cm it can fit tiny surfaces perfectly.

Un présentoir au design soigné et actuel, à personnaliser pour le coordonner au style du point de vente.

Orleans est particulièrement indiqué pour les pâtisseries, les pains, les plats préparés, les sandwiches et, en général, pour les magasins de petites dimensions: grâce à sa largeur de 81 cm, il peut être inséré dans des espaces réduits.

Ein Aussteller mit einem präzisen und aktuellen Design, das an den Stil der Verkaufsstelle angepasst werden kann.

Orleans eignet sich besonders für Süßwaren, Brot, Gastronomie, Sandwiches und im Allgemeinen für kleine Läden: dank seiner Breite von 81 cm kann es auch in kleineren Räumen aufgestellt werden.



D97 Black Version C-1

ORLEANS



1

Vetro intermedio con illuminazione.
Intermediate shelf with lighting.
Vitre intermédiaire avec éclairage.
Zwischenglaselage mit Beleuchtung.

2

Cappello in vetro.
Upper glass.
Chapeau en verre.
Zahlplatte aus Glas.

3

Struttura con vetro fisso.
Structure with fixed glass.
Structure avec verre fixe.
Struktur mit festen Glas.

4

Illuminazione LED.
LED lighting.
Éclairage LED
LED-Beleuchtung

5

Zona esposizione in acciaio Inox.
Display area in stainless steel.
Zone d'exposition en acier inox.
Auslagefläche aus Edelstahl.

White
Version
C-1

D110

ORLEANS Versions

Gray Black Optional

Colori spalla
End colours
Couleurs des côtés
Farben für Rückwände



Esposizione e illuminazione ottimali con i ripiani intermedi in vetro.
Optimal display and lighting thanks to its intermediate glass shelves.
Exposition et éclairage optimaux avec des étagères intermédiaires en verre
Optimale Präsentation und Beleuchtung mit den Zwischenregalen aus Glas



Piano di lavoro in granito (Rosa Beta) – Optional Nero assoluto.
Granite worktop (Rosa Beta) – Optional Absolute Black.
Plan de travail en granit (Rosa Beta) – En option, Noir absolu.
Granit-Arbeitsplatte (Rosa Beta) – Optional tiefschwarz.



Esposizione ideale per i vostri piatti di gastronomia.
Ideal for displaying gastronomic dishes.
Exposition idéale pour vos plats préparés.
Idealer Aussteller für Ihre kulinarischen Kreationen.

C-1

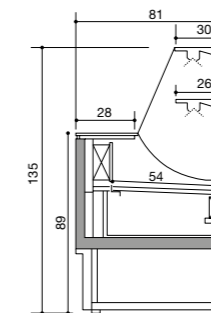

Statico con cella
Static with cool storage
Statique avec réserve
Statisch mit Unterbaukuehlung

C-3

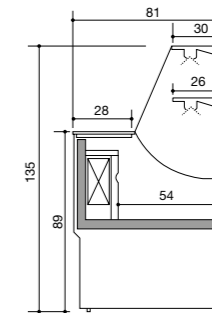

Statico senza cella
Static without cool storage
Statique sans réserve
Statisch ohne Unterbaukuehlung

C-5

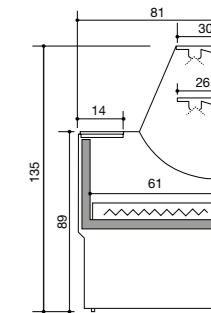

Versione calda (60°C)
Hot Version (60°C)
Version chaude (60°C)
Warme Ausfuerung (60°)

KRISTALL



Width in cm.

78



Length in cm.

100 · 120
150



Climate class

3 M1
25°C / u.r. 60%

Carisma e stile per una visibilità al top.

Kristall è l'espositore perfetto per la vendita di prodotti di qualità, in grado di offrire loro tutta la visibilità che meritano. È ideale per prodotti gastronomici, pasticceria e dolci, sandwich o piatti pronti.

Charisma and style for utmost visibility.

Kristall is perfect for enhancing high quality products, offering them all the visibility they deserve. Ideal for gastronomic products, pastry creations and cakes, sandwiches or ready meals.

Charisme et style pour une meilleure visibilité.

Kristall est le présentoir parfait pour la vente de produits de qualité, il est en mesure de leur offrir toute la visibilité qu'ils méritent. Il est parfait pour les produits préparés, les pâtisseries, les sandwiches ou les plats à emporter.

Charisma und Stil für höchste Sichtbarkeit.

Kristall ist die perfekte Auslage für den Verkauf von Qualitätsprodukten, die gebührend in Szene gesetzt werden sollen. Es eignet sich hervorragend für gastronomische Produkte, Gebäck und Kuchen, Sandwiches oder Fertiggerichte.



D97 Black Version C-4

KRISTALL

White Oak
Version
C-4

D136

D110

White
Version
C-4



1

Vetri Thermopane con serigrafia in nero.

Thermopane glasses with black serigraphy.

Vitres Thermopane sérigraphies noir.

Thermopane-Verglasungen mit schwarz Serigraphie.

2

Illuminazione verticale a LED.

LED lighting.

Éclairage LED

LED-Beleuchtung

3

Zona esposizione verniciata nero.

Display area black painted.

Zone d'exposition peint en noir.

Auslagefläche schwarz lackiert.

4

Ripiani in vetro refrigerati.

Refrigerated glass shelves.

Étagères en verre réfrigérées.

Gekühlte Glasregale.

5

Porte scorrevoli posteriori in Thermopane.

Rear sliding doors in Thermopane glass.

Portes coulissantes arrières en Thermopane.

Hintere Glasschiebetüren aus Thermopan



KRISTALL
Versions



Gray **Black** Optional

Colori spalla
End colours
Couleurs des côtés
Farben für Rückwände

C-4

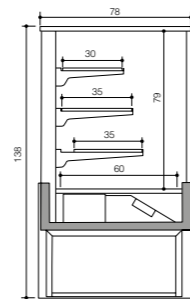

Ventilato senza cella
Ventilated without cool storage
Ventiléé sans réserve
Umluft ohne Unterbaukuehlung

C-5

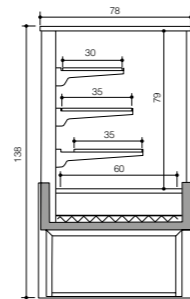

Versione calda (60°C)
Hot Version (60°C)
Version chaude (60°C)
Warme Ausfuerung (60°)

C-6

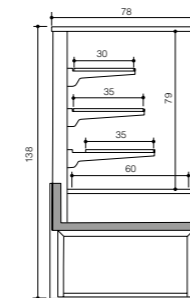

Non refrigerato
Not refrigerated cabinet
Sans réfrigération
Nicht gekühlte Theke

You sure can
see it all!



Z•IN



Width in cm.

91



Length in cm.

100 · 150
200 · 250
300



Climate class

3 M2
25°C / u.r. 60%

Studiato per attirare l'attenzione.

Patagonia è il modello di banco refrigerato ideale per attrarre i clienti: una vetrina perfetta per l'esposizione di prodotti di gastronomia, sandwich e piatti ready-to-eat. È disponibile con il vetro retto oppure con il vetro curvo.

Design to catch attention.

A refrigerated counter to attract consumers' attention: the perfect counter to display gastronomic products, sandwiches and ready meals. Available with straight or curved glass.

Conçu pour attirer l'attention.

Patagonia est le modèle de comptoir réfrigéré idéal pour attirer les clients: une vitrine parfaite pour l'exposition de produits préparés, de sandwiches et de plats à emporter. Il est disponible avec une vitrine droite ou bien bombée.

Als Blickfang entwickelt.

Patagonia ist das ideale Kühltheckenmodell, um den Blick der Kunden auf sich zu ziehen: eine perfekte Vitrine für die Präsentation von Feinkostprodukten, Sandwiches und verzehrfertigen Gerichten. Es ist mit geradem oder gebogenem Glas erhältlich.

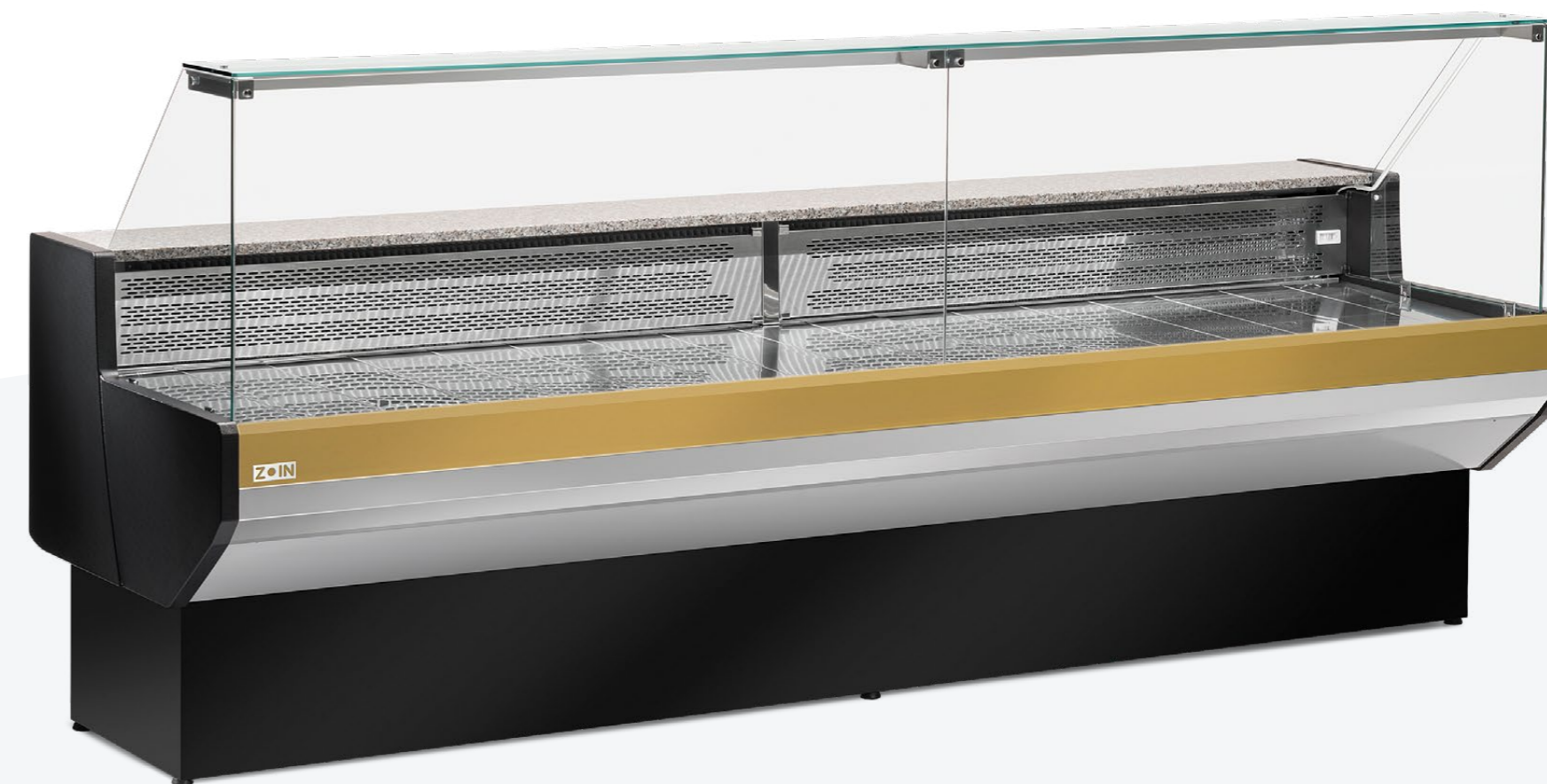

D153 Magic Gold Version C-1

PATAGONIA



1

Struttura cappello in vetro curvo temperato.

Cap in curved tempered glass.

Structure plafond avec vitrine bombée en verre trempé.

Haubenstruktur aus gebogenem, gehärtetem Glas.

2

Illuminazione LED.

LED lighting.

Éclairage LED

LED-Beleuchtung

3

Zona esposizione in acciaio Inox.

Display area in stainless steel.

Zone d'exposition en acier inox.

Auslagefläche aus Edelstahl.

4

Piano lavoro in granito (Rosa Beta).

Working plate in granit (Rosa Beta).

Plan de travail en granit (Rosa Beta).

Arbeitsplatte aus (Rosa Beta).

Splendido
Azzurro
Y-2 D107

D97 Black
Version Y-2



White Butter
Version C-1 D151



D153 Magic Gold

Urban Wood D137

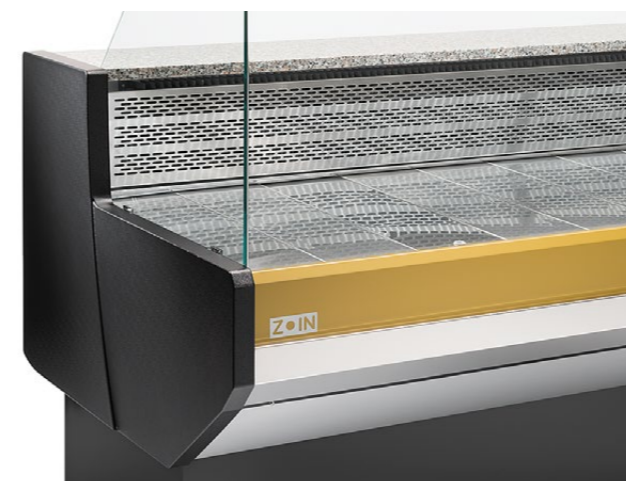

PATAGONIA

Versions

Gray Black Optional

Colori spalla
End colours
Couleurs des côtés
Farben für Rückwände

C-1

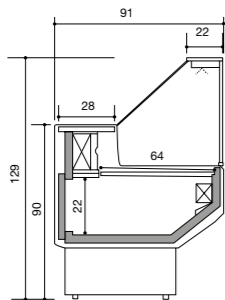

Statico con cella
Static with cool storage
Statique avec réserve
Statisch mit Unterbaukuehlung

C-2

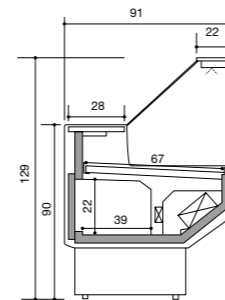

Ventilato con cella
Ventilated with cool storage
Ventiléé avec réserve
Umluft mit Unterbaukuehlung

Y-1

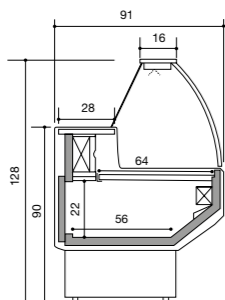

Statico con cella
Static with cool storage
Statique avec réserve
Statisch mit Unterbaukuehlung

Y-2

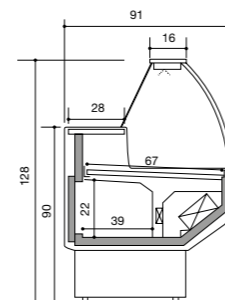

Ventilato con cella
Ventilated with cool storage
Ventiléé avec réserve
Umluft mit Unterbaukuehlung



Eye-catching by design.

Z•IN

TIBET



Width in cm.

79



Length in cm.

100 · 150
200 · 250
300



Climate class

3 M2
25°C / u.r. 60%

Fai grande il tuo punto vendita in poco spazio.

Tibet è l'espositore perfetto per gli ambienti più ristretti, grazie ai suoi soli 79 cm di larghezza totale.

È studiato per massimizzare l'esposizione di salumi, formaggi e piatti pronti, l'ideale per ogni esigenza che richieda un banco refrigerato.

Make your store big in small space.

With a total width of only 79 cm, Tibet is perfect for small stores. Designed to enhance cold cuts, cheese and ready meals, can cater to any refrigerated counter needs.

Votre espace de vente s'agrandit sur peu d'espace.

Tibet est le présentoir parfait pour les espaces les plus restreints, grâce à sa largeur totale de 79 cm. Il est conçu pour maximiser l'exposition de charcuteries, de fromages et de plats préparés, l'idéal pour chaque exigence qui requiert un comptoir réfrigéré.

Machen Sie Ihr Geschäft auf kleinem Raum groß.

Tibet ist dank seiner Gesamtbreite von nur 79 cm die perfekte Auslage für kleinste Räume. Es wurde für die Auslage von Aufschnitt, Käse und Fertiggerichten entwickelt und ist ideal für jeden Einsatz, der eine Kühltheke erfordert.



D97 Black Version C-1

TIBET

Green
Version
B-1

D101

White Oak
Version
B-1

D136



1

Struttura e cappello in vetro.
Top and upper glass structure.
Structure et chapeau en verre.
Glas und Zahlplatte Struktur.

2

Illuminazione LED.
LED lighting.
Éclairage LED
LED-Beleuchtung

3

Zona esposizione in acciaio Inox.
Display area in stainless steel.
Zone d'exposition en acier inox.
Auslagefläche aus Edelstahl.

4

Nr. 1 vetro intermedio.
Nr. 1 intermediate shelf.
Nr. 1 vitre intermédiaire.
Nr. 1 Zwischenglaselage.

5

Piano lavoro in granito (Rosa Beta).
Working plate in granit (Rosa Beta).
Plan de travail en granit (Rosa Beta).
Arbeitsplatte aus (Rosa Beta).



TIBET Versions

Gray Black Optional

Colori spalla
End colours
Couleurs des côtés
Farben für Rückwände

B-1

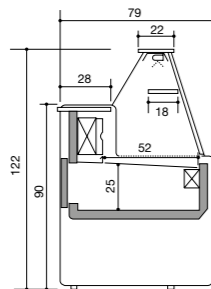

Statico con cella - Vetro dritto

Static with cool storage -
Straight glass

Statique avec réserve - Vitre droite

Statisch mit Unterbaukuehlung -
Gerades Glas

C-1

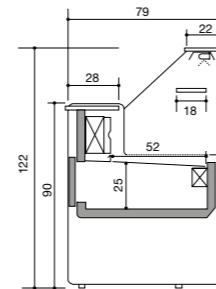

Statico con cella - Vetro retto

Static with cool storage -
Upright glass

Statique avec réserve - Vitre verticale

Statisch mit Unterbaukuehlung -
Rechteckiges Glas

Unlimited performance
in a limited space.



Z•IN

SAIGON



La soluzione più efficiente per la vendita del pesce.

Importante quanto delicata, l'esposizione del pesce necessita di un prodotto professionale ad hoc: Saigon è lo strumento perfetto per questa tipologia di alimento. I pratici gamboni in acciaio Inox, forniti di serie, garantiscono facile e veloce pulizia dell'ambiente.

The most efficient solution for the sale of fish.

The delicate displaying and preservation of fish require a professional and specifically designed product: Saigon is the perfect counter for fish. The convenient stainless steel support legs, now provided as standard, enable fast and easy cleaning.

La solution la plus efficace pour la vente de poissons.

L'exposition du poisson est importante et délicate et nécessite d'un produit professionnel ad hoc: Saigon est l'outil parfait pour cette typologie d'aliment. Les gros pieds pratiques en acier inox, fournis de série, garantissent un nettoyage rapide et facile de l'espace de vente.

Die effizienteste Lösung für den Verkauf von Fisch.

Die wichtige und delikate Präsentation von Fisch benötigt ein professionelles Ad-hoc-Produkt: Saigon ist der perfekte Aussteller für diese Art von Lebensmitteln. Die praktischen Edelstahlbeine, die serienmäßig mitgeliefert werden, ermöglichen eine einfache und schnelle Reinigung der Räumlichkeiten.

S-3

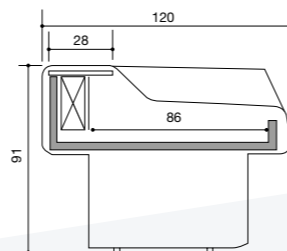

Y-3

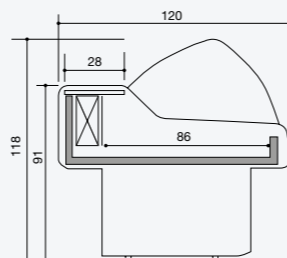

1

Ideale per esposizione e vendita del pesce.

Ideal for display and sale of fish.

Ideal pour l'exposition et la vente de poisson.

Ideal für die Ausstellung und Verkauf von Fisch.

2

Zona esposizione in acciaio AISI 316.

Display area in stainless steel AISI 316.

Zone d'exposition en acier AISI 316.

Auslagefläche aus Edelstahl AISI 316.

3

Piano lavoro in granito (Rosa Beta).

Working plate in granit (Rosa Beta).

Plan de travail en granit (Rosa Beta).

Arbeitsplatte aus (Rosa Beta).

4

Vetro curvo.

Curved glass.

Vitre bombée.

Gebogene Scheibe.

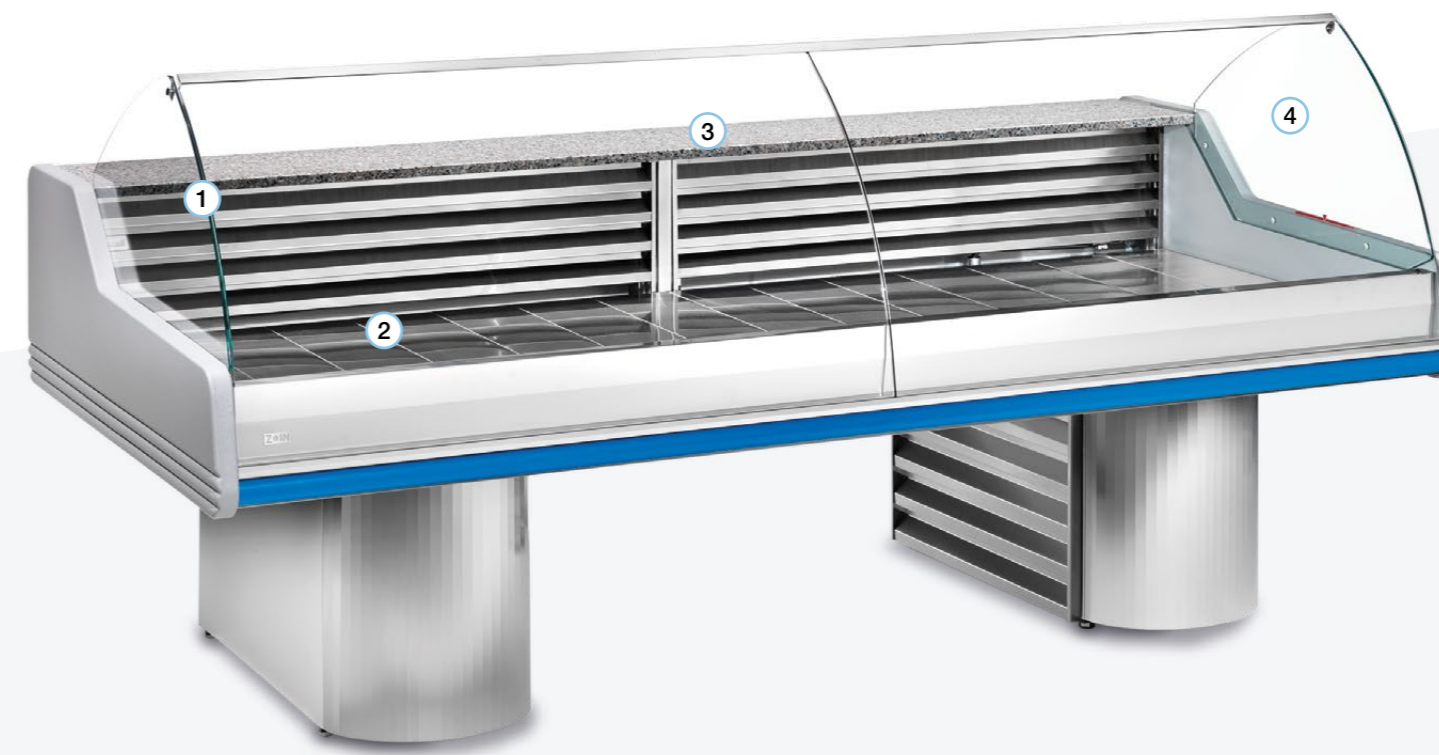

Gray

Colori spalla
End colours
Couleurs des côtés
Farben für Rückwände



Width in cm.

120



Length in cm.

150 · 200 · 250
300 · 350



Climate class

3 M1
25°C / u.r. 60%

Version
Y-3

MELODY



Un modello senza tempo.

Melody è sinonimo di tradizione e robustezza, un modello che non segue le mode del momento. L'abbiamo progettato per la presentazione e la vendita di salumi, formaggi e altri prodotti di gastronomia.

A timeless model.
Melody rhymes with tradition and robustness without conforming with new trends. It has been designed for the display of cold cuts, cheese and gastronomic products in general.

Un modèle intemporel.
Melody est synonyme de tradition et de robustesse, un modèle qui ne suit pas les modes actuelles. Nous l'avons conçu pour la présentation et la vente de charcuteries, de fromages et d'autres produits préparés.

Ein zeitloses Modell.
Melody ist ein Synonym für Tradition und Stabilität, ein Modell, das sich nicht an den Moden des Augenblicks orientiert. Wir haben es für die Präsentation und den Verkauf von Wurstwaren, Käse und anderen gastronomischen Produkten konzipiert.

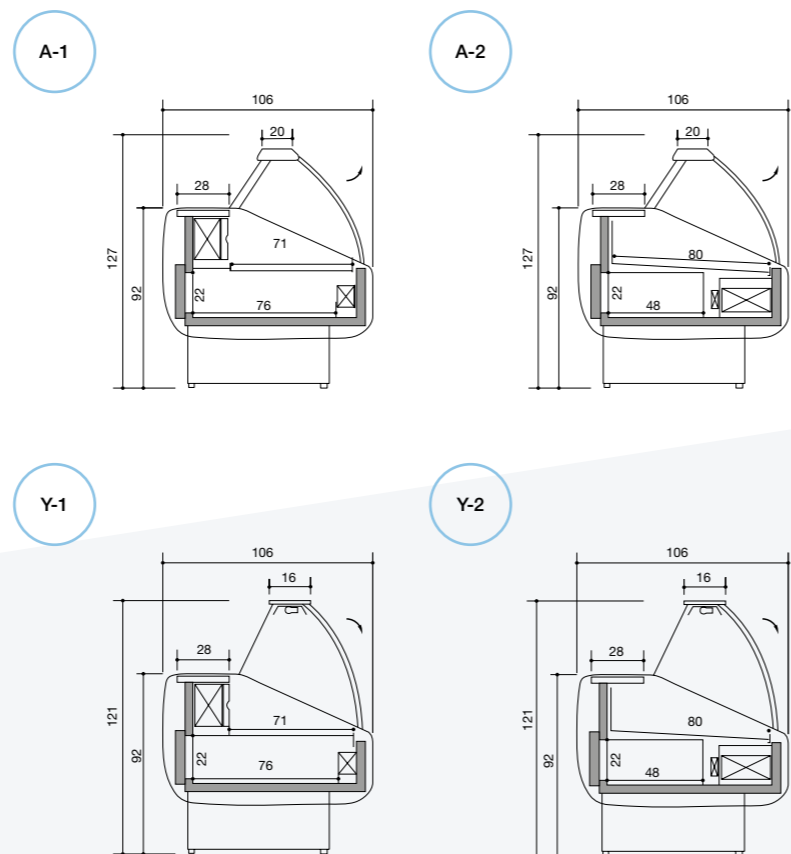

1

illuminazione LED.
LED lighting.
Éclairage LED.
LED-Beleuchtung.

2

Zona esposizione in acciaio Inox.
Display area in stainless steel.
Zone d'exposition en acier inox.
Auslagefläche aus Edelstahl.

3

Piano lavoro in granito (Rosa Beta).
Working plate in granit (Rosa Beta).
Plan de travail en granit (Rosa Beta).
Arbeitsplatte aus (Rosa Beta).

4

A1- A2: Struttura servoassistita.
A1- A2: Servo-assisting upsetting glass.
A1- A2: Overture servoassistite.
A1- A2: Hebescheibenstruktur.

5

Y1-Y2: vetri apribili a compasso.
Y1-Y2: bottom-hung glass.
Y1-Y2: vitre rabattable.
Y1-Y2: Gerade Kippscheiben.



D96 Red Version Y-2

Gray

Colori spalla
End colours
Couleurs des côtés
Farben für Rückwände



Width in cm.
106



Length in cm.
150 · 200 · 250
300 · 350 · 400



Climate class
3 M2
25°C / u.r. 60%

COLORADO



Width in cm.

98



Length in cm.

140 · 220
290



Climate class

3 H2
25°C / u.r. 60%

Eleganza per la pasticceria.

La vetrina perfetta per esporre la pasticceria refrigerata o secca con un'eleganza e una capacità espositiva che non hanno eguali. Progettato per massimizzare l'esposizione verticale, Colorado è un banco elegante che si armonizza con ogni ambiente di vendita.

Elegance at the pastry shop.

This display is perfect to showcase both fresh and dry pastry creations with unparalleled elegance and display quality. Designed to enhance vertical display, Colorado is an elegant counter that attunes with any styles and store.

Élégance pour la pâtisserie.

La vitrine parfaite pour exposer les pâtisseries réfrigérées ou sèches avec une élégance et une capacité d'exposition sans pareil. Conçue pour maximiser l'exposition verticale, Colorado est un présentoir élégant qui s'harmonise très bien avec n'importe quel espace de vente.

Eleganz für die Feinbäckerei.

Die perfekte Vitrine für die Präsentation von gekühltem oder trockenem Gebäck mit einer Eleganz und Auslagekapazität, die ihresgleichen sucht. Colorado ist eine elegante Theke, die für eine maximale vertikale Präsentation ausgelegt ist und sich harmonisch in jede Verkaufsumgebung einfügt.



D136 White Oak
Version
C-3

COLORADO

White Butter
Version
Y-3 D151

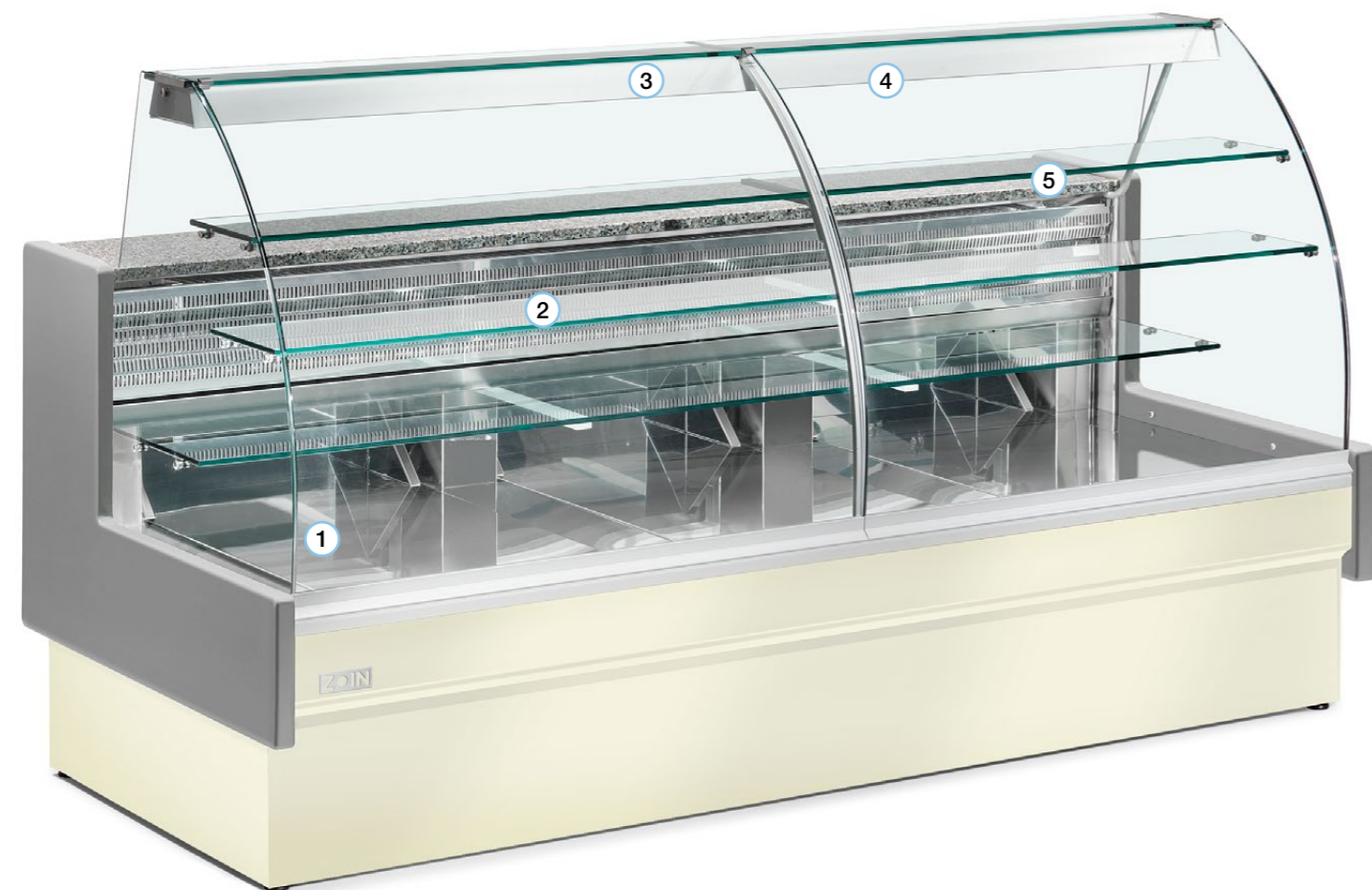

1

Zona esposizione in acciaio Inox.
Display area in stainless steel.
Zone d'exposition en acier inox.
Auslagefläche aus Edelstahl.

2

Ripiani in vetro non refrigerati.
Non-refrigerated glass shelves.
Étagères en verre non réfrigérées.
Nicht-gekühlte Glasregale.

3

Vetri apribili a compasso (C-3 e Y-3).
Bottom-hung glass (C-3 e Y-3).
Vitre rabattable (C-3 e Y-3).
Gerade Kippscheiben (C-3 e Y-3).

4

Illuminazione LED.
LED lighting.
Éclairage LED.
LED-Beleuchtung.

5

Piano lavoro in granito (Rosa Beta).
Working plate in granit (Rosa Beta).
Plan de travail en granit (Rosa Beta).
Arbeitsplatte aus (Rosa Beta).

COLORADO Versions

Gray Black Optional

Colori spalla.
La parte inferiore della spalla è personalizzabile con il colore del frontale scelto.

End colours.
The lower part of the sidewall can be customised with the colour of the chosen front.

Couleurs des côtés.
La partie inférieure du côté est personnalisable avec la couleur de la face avant choisie.

Farben für Rückwände.
Der untere Teil der Rückwand kann farblich an die gewählte Front angepasst werden.

C-3

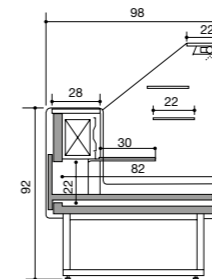

Y-3

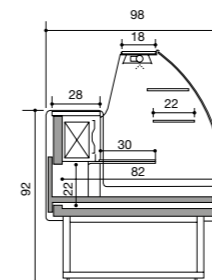

Statico con cassettoni scorrevole
Static with slidign drawer
Statique avec tiroir coulissant
Statisch mit schublade

Statico con cassettoni scorrevole
Static with slidign drawer
Statique avec tiroir coulissant
Statisch mit schublade





1

Cappello in vetro.
Upper glass.
Chapeau en verre.
Zahlplatte aus Glas.

2

illuminazione LED.
LED lighting.
Éclairage LED.
LED-Beleuchtung.

3

Zona esposizione in acciaio Inox.
Display area in stainless steel.
Zone d'exposition en acier inox.
Auslagefläche aus Edelstahl.

Pronto a soddisfare tutte le esigenze.

VR è l'espositore refrigerato versatile ed economico adatto a qualsiasi esigenza. Ideale nel mondo della ristorazione per esibire piatti pronti, sandwich, prodotti gastronomici o pesce fresco.

Ready to cater to your needs.
VR is a versatile and low-cost refrigerated counter that can suit any needs. Perfect for catering display of ready dishes, sandwiches, gastronomic products or fresh fish.

Prêt pour satisfaire toutes les exigences.
VR est le présentoir réfrigéré universel et économique adapté à toutes les exigences. Il est idéal dans le monde de la restauration pour présenter les plats préparés, les sandwichs, les produits gastronomiques ou les poissons frais.

Bereit, allen Anforderungen gerecht zu werden.
VR ist der vielseitige und preisgünstige Kühlaussteller, der für jeden Bedarf geeignet ist. Ideal in der Welt der Gastronomie, um Fertiggerichte, Sandwiches, kulinarische Produkte oder frischen Fisch auszustellen.

B-7

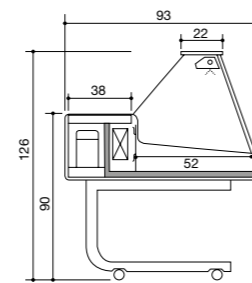

S-7

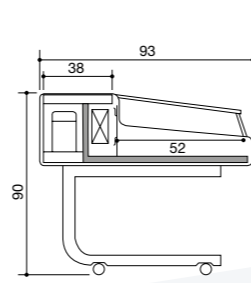

Y-7

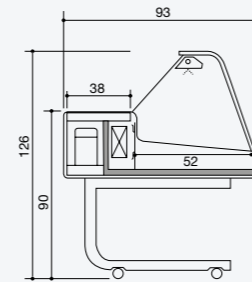

Y-7 Fish

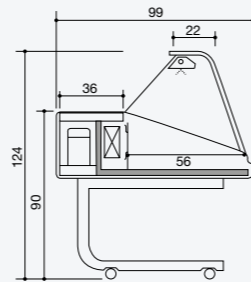

Gray

Colori spalla
End colours
Couleurs des côtés
Farben für Rückwände



Width in cm.

93/99



Length in cm.

100 · 150



Climate class

Y7: 3 M2
Y7 Fish: 3 M1
25°C / u.r. 60%

Version
Y-7



Massima visibilità per i nuovi concept store.

Il banco murale refrigerato Chamonix è studiato per garantire massimo risalto al prodotto esposto nei nuovi concept store. Ideale per prodotti quali salumi, formaggi, frutta e verdura, take-away e bibite.

Utmost visibility for new concept stores.

Chamonix is a refrigerated wall display perfect for ensuring the utmost enhancement of products in new concept stores. Ideal for products such as cold cuts, cheese, fruits and vegetables, take away dishes and drinks.

Grande visibilité pour les nouveaux concepts stores.

Le présentoir mural réfrigéré Chamonix a été conçu pour présenter de manière plus efficace les produits exposés dans les nouveaux concepts stores. Il est idéal pour les produits comme les charcuteries, les fromages, les fruits et les légumes, les plats à emporter et les boissons.

Maximale Sichtbarkeit für die neuen Concept Stores.

Die Wand-Kühltheke Chamonix ist so konzipiert, dass sie eine maximale Sichtbarkeit der in den neuen Concept Stores ausgestellten Produkte garantiert. Ideal für Aufschnitt, Käse, Obst und Gemüse, Take-away und Erfrischungsgetränke.



Width in cm.

75



Length in cm.

70 · 100 · 120
150 · 180 · 200



Climate class

B200: 3-M2
B200 VIEW: 3-M1



Shelf Depth in cm.

34



Load capacity in lt.

70 = 284 lt.
100 = 422 lt.
120 = 514 lt.
150 = 651 lt.
180 = 789 lt.
200 = 881 lt.

D97 Black Version B-200 VIEW

CHAMONIX



D138 Larchwood
Version
B-200

1

Zona esposizione in acciaio Inox.
Display area in stainless steel.
Zone d'exposition en acier inox.
Auslagefläche aus Edelstahl.

2

Illuminazione LED.
LED lighting.
Éclairage LED
LED-Beleuchtung

3

Ripiani inclinabili e regolabili
in altezza.
Inclinable and height adjustable
shelves.
Étagères inclinables et réglables
en hauteur.
Möglichkeit von schräger und
höhenverstellbare Fachböden.

4

Spalla panoramica (Optional).
Panoramic sidewalls (Optional).
Côté Panoramique (En option).
Panorama-Rückwand (Optional).



D102 Orange
Version
B-200



CHAMONIX Versions

Gray Black Optional

Colori spalla
End colours
Couleurs des côtés
Farben für Rückwände

B-200

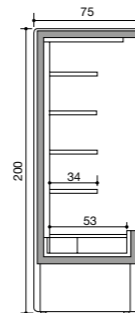

4 ripiani
4 shelves
4 étagères
4 Fachböden

B-200
View

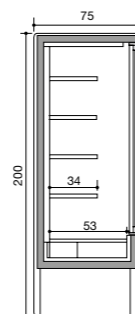

4 ripiani - porte scorrevoli
4 shelves - sliding doors
4 étagères - porte coulissantes
4 Fachböden - Schiebetüren

F-200

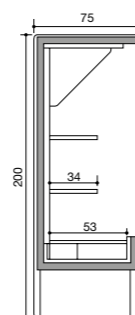

2 ripiani con specchio
2 shelves with mirror
2 étagères avec miroir
2 Fachböden mit spiegel



A whole new concept
for concept stores.

Z•IN

CERVINO



Semplicità, design, convenienza.

Design accattivante, versatilità e ottimo rapporto qualità-prezzo sono gli ingredienti per Cervino, il murale “Freshness to go”. Dal concetto costruttivo semplice – con ripiani in appoggio e blocchi ancorati alle spalle – è adatto per l’esposizione di salumi, formaggi, frutta e verdura, take-away e bibite.

Simplicity, design and value for money.

Attractive design, versatility and excellent value for money are the ingredients for Cervino, the “Freshness to go” refrigerated wall display. Its clean design - with supporting shelves and blocks fixed to the sides - is ideal for displaying cold cuts, cheese, fruits and vegetables, take away dishes and drinks.

Simple, design, avantageux.

Le design attrayant, l'universalité et l'excellent rapport qualité-prix sont les qualités de Cervino, le présentoir mural “Freshness to go”. Grâce à son concept de construction très simple – avec des étagères en appui sur les joues ancrées aux côtés – il convient parfaitement pour l'exposition des charcuteries, des fromages, des fruits et des légumes, des plats prêts à emporter et des boissons.

Schlichtheit, Design, Zweckmäßigkeit.

Ansprechendes Design, Vielseitigkeit und ein ausgezeichnetes Preis-Leistungs-Verhältnis sind die Eigenschaften von Cervino, das Wandkühlregal „Freshness to go”. Mit seinem einfachen Aufbaukonzept - die Regale tragenden an den Rückwänden verankerten Blöcke - eignet es sich für die Auslage von Aufschnitt, Käse, Obst und Gemüse, Take-away und Erfrischungsgetränken.



Width in cm.

71



Length in cm.

70 · 100 · 120
150 · 180



Climate class

A-200: 3 M2
A-200 VIEW: 3 M1



Shelf Depth in cm.

34



Load capacity in lt.

70 = 284 lt.
100 = 422 lt.
120 = 514 lt.
150 = 651 lt.
180 = 789 lt.

D107 Splendido
Azzurro
A-200

CERVINO



D137 Urban Wood
Version
A-200 VIEW

1

Ripiani in appoggio su blocchi ancorati alle spalle.

Supporting shelf-blocks fixed to the sides.

Étagères en appui sur les joues ancrées aux côtés.

Regale, die auf an den Rückwänden verankerten Blöcken aufliegen.

2

Illuminazione LED.

LED lighting.

Éclairage LED

LED-Beleuchtung

3

Zona esposizione in acciaio Inox.

Display area in stainless steel.

Zone d'exposition en acier inox.

Auslagefläche aus Edelstahl.

4

Porte scorrevoli in vetro Thermopane.

Sliding doors in Thermopane glass.

Portes coulissantes en verre Thermopane.

Thermopanglas-Schiebetüren.

D136 White Oak
Version
A-200 with Night Curtain

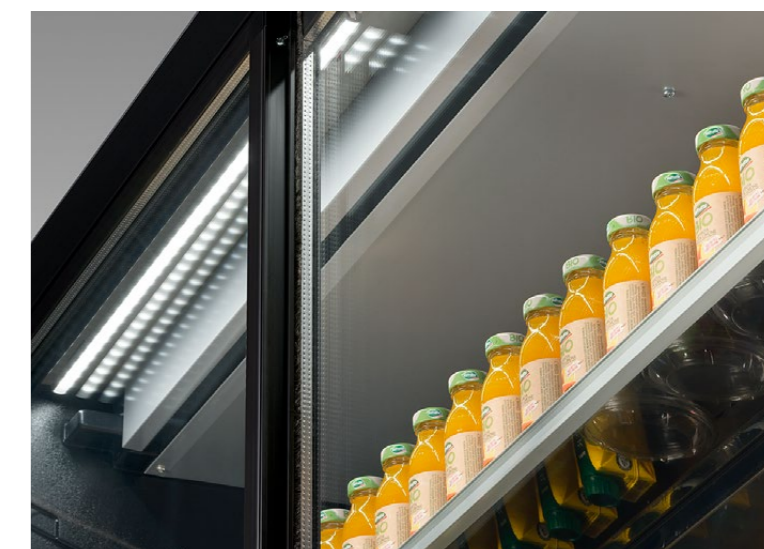

CERVINO Versions

Gray Black Optional

Colori spalla
End colours
Couleurs des côtés
Farben für Rückwände



A-200

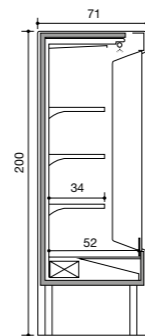

- 3 ripiani
- 3 shelves
- 3 étagères
- 3 Fachböden

A-200
View

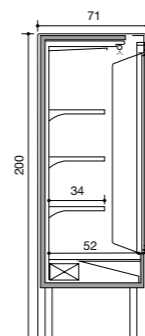

- 3 ripiani - porte scorrevoli
- 3 shelves - sliding doors
- 3 étagères - porte coulissantes
- 3 Fachböden - Schiebetüren

Black
Version
A-200 D97



Freshness to go.

ZOIN



La migliore soluzione espositiva per sfruttare gli spazi.

Olimpo è il nuovo murale refrigerato a profondità ridotta – solo 57 cm – per i piccoli punti vendita. È disponibile sia con ripiani inclinabili e registrabili in altezza, sia con ripiani in appoggio su blocchi ancorati alle spalle.

Sviluppato per l'esposizione di prodotti gastronomici come salumi, formaggi e bibite.

The best display solution to make the most of any space.

Olimpo is the new refrigerated wall display, reduced in thickness - only 57 cm - for small stores. It is available both with tilting and height-adjustable shelves and with supporting shelf-blocks fixed to the sides. Designed for the display of gastronomic products, such as cold cuts, cheese and drinks.

La meilleure solution d'exposition pour exploiter les espaces.

Olimpo est le nouveau présentoir mural réfrigéré avec une profondeur réduite – seulement 57 cm – pour les petits points de vente. Il est disponible aussi bien avec des étagères inclinables et réglables en hauteur qu'avec des étagères en appui sur des joues ancrées aux côtés. Il a été développé pour exposer des produits gastronomiques comme les charcuteries, les fromages et les boissons.

Die Präsentationslösung zur besten Raumausnutzung.

Olimpo ist das neue Wandkühlregal mit reduzierter Tiefe - nur 57 cm - für kleine Verkaufsstellen. Es ist sowohl mit kippbaren und höhenverstellbaren Regalen als auch mit Regalen erhältlich, die auf an den Rückwänden verankerten Blöcken ruhen. Entwickelt für die Ausstellung von gastronomischen Produkten wie Aufschnitt, Käse und Erfrischungsgetränken.



D153 Magic Gold Version B-200 VIEW



Width in cm.

57



Length in cm.

70 · 100
120 · 150
180 · 200



Climate class

A-200, B-200: 3 M2
A e B-200 VIEW: 3 M1



Shelf Depth in cm.

29



Load capacity in lt.

70 = 242 lt.
100 = 360 lt.
120 = 438 lt.
150 = 555 lt.
180 = 673 lt.
200 = 751 lt.



1

Zona esposizione in acciaio Inox.
Display area in stainless steel.
Zone d'exposition en acier inox.
Auslagefläche aus Edelstahl.

2

Illuminazione LED.
LED lighting.
Éclairage LED
LED-Beleuchtung

3

B200 – B200 VIEW: Ripiani inclinabili e regolabili in altezza.
B200 – B200 VIEW: Tilting and height-adjustable shelves.
B200 – B200 VIEW: Étagères inclinables et réglables en hauteur.
B200 – B200 VIEW: Kippbare höhenverstellbare Regale.

4

A200 – A200 VIEW: Ripiani in appoggio su blocchi ancorati alle spalle.
A200 – A200 VIEW: Shelves resting on blocks anchored to the sidewalls.
A200 – A200 VIEW: Étagères en appui sur des joues ancrées aux côtés.
A200 – A200 VIEW: Regale, die auf an den Rückwänden verankerten Blöcken ruhen.

5

Spalla panoramica (Optional).
Panoramic sidewalls (Optional).
Côté Panoramique (En option).
Panorama-Rückwand (Optional).



OLIMPO Versions

Gray Black Optional

Colori spalla
End colours
Couleurs des côtés
Farben für Rückwände

A-200

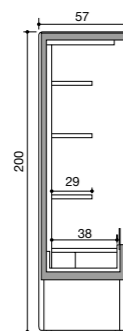

3 ripiani
3 shelves
3 étagères
3 Fachböden

A-200
View

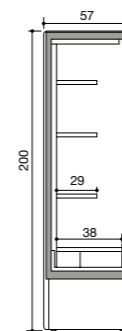

3 ripiani - porte scorrevoli
3 shelves - sliding doors
3 étagères - porte coulissantes
3 Fachböden - Schiebetüren

B-200

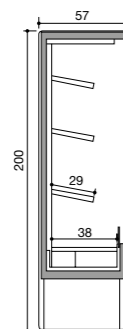

3 ripiani
3 shelves
3 étagères
3 Fachböden

B-200
View

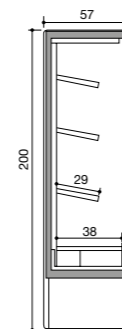

3 ripiani - porte scorrevoli
3 shelves - sliding doors
3 étagères - porte coulissantes
3 Fachböden - Schiebetüren



So slim it can fit anywhere.

Z•IN

SILVER



Width in cm.
75



Length in cm.
70 · 100
120 · 150
180 · 200



Climate class
B200: 3 M2
B200 VIEW: 3 M1
25°C / u.r. 60%



Shelf Depth in cm.
34



Load capacity in lt.
70 = 257 lt.
100 = 381 lt.
120 = 464 lt.
150 = 589 lt.
180 = 713 lt.
200 = 796 lt.

Resistenza garantita.

Vi sono esigenze espositive che necessitano di una maggiore resistenza dei materiali costruttivi che potrebbero, direttamente o indirettamente, entrare in contatto con il prodotto alimentare. Per soddisfarle c'è Silver, con tutte le finiture interne della vasca e dei suoi componenti in acciaio Inox.

Guaranteed robustness.

When display materials may directly or indirectly come in contact with food, more resistant construction materials are demanded. The answer is Silver: the internal finishes of its tank are in stainless steel, as are its components.

Résistance garantie.

Il existe des exigences d'exposition qui nécessitent d'une plus grande résistance des matériaux de construction qui pourraient directement ou indirectement, rentrer en contact avec le produit alimentaire. Pour les satisfaire, voici Silver, avec toutes les finitions internes du bac et de ses composants en acier inox.

Garantierte Widerstandsfähigkeit.

Es gibt Ausstellungssituationen, die eine höhere Beständigkeit von Materialien erfordern, die direkt oder indirekt mit Lebensmitteln in Kontakt kommen können. Um ihnen gerecht zu werden gibt es Silver. Hier ist die gesamte Verkleidung der Innenschale und ihrer Komponenten aus rostfreiem Stahl.

B-200

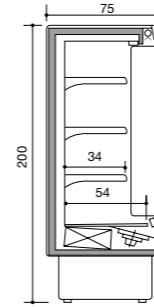

B-200 View

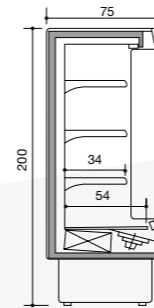

I301 Scotch Brite

Colori spalla
End colours
Couleurs des côtés
Farben für Rückwände

I301 Scotch Brite
Version
B-200 VIEW



1

Zona esposizione, vasca interna e finiture esterne in acciaio inox.

Stainless steel display area, internal tank and external finishes.

Zone d'exposition, bac interne et finitions externes en acier inox.

Ausstellungsbereich, Innenschale und Außenverkleidung aus Edelstahl.

2

Illuminazione LED.

LED lighting.

Éclairage LED.

LED-Beleuchtung.

3

Ripiani inclinabili e regolabili in altezza.

Inclinable and height adjustable shelves.

Étagères inclinables et réglables en hauteur.

Möglichkeit von schräger und höhenverstellbare Fachböden.

DANNY



Width in cm.
75



Length in cm.
100 · 120
150 · 180
200



Climate class
3 M2
25°C / u.r. 60%



Shelf Depth in cm.
34



Load capacity in lt.
100= 381 lt.
120=464 lt.
150=589 lt.
180=713 lt.
200=796 lt.

Piccole superfici, grandi performance.

Danny è il murale refrigerato dalle dimensioni contenute, perfetto da posizionare all'interno di locali con superfici ridotte. Adatto all'esposizione di salumi, formaggi, frutta e verdura, take-away e bibite.

Small surfaces, big performance.
Danny is a wall refrigerated display that fit into small retail spaces. Ideal for displaying cold cuts, cheese, fruits and vegetables, take away dishes and drinks.

Petites surfaces, grandes performances.
Danny est le présentoir mural réfrigéré aux dimensions limitées, il est parfait pour être positionné dans des pièces ayant des surfaces réduites. Il convient parfaitement pour exposer des charcuteries, des fromages, des fruits et des légumes, des plats prêts à emporter et des boissons.

Kleine Flächen, große Leistung.
Danny ist das gekühlte Wandregal mit kleinen Abmessungen, das sich perfekt in Räumen mit kleinen Flächen einsetzen lässt. Geeignet für die Auslage von Aufschnitt, Käse, Obst und Gemüse, Take-away und Erfrischungsgetränken.

B-180

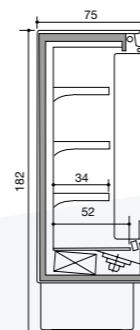

Gray

Colori spalla
End colours
Couleurs des côtés
Farben für Rückwände

D103 Blue Version B-180



1

Ripiani inclinabili e regolabili in altezza.

Inclinable and height adjustable shelves.

Étagères inclinables et réglables en hauteur.

Möglichkeit von schräger und höhenverstellbare Fachböden.

2

Illuminazione LED.

LED lighting.

Éclairage LED.

LED-Beleuchtung.

3

Zona esposizione in acciaio Inox.

Display area in stainless steel.

Zone d'exposition en acier inox.

Auslagefläche aus Edelstahl.



Un murale grande per grandi performance.

Mauna è il nuovo murale refrigerato che si distingue per le alte prestazioni e l'elevata capacità di carico. È particolarmente adatto ai locali che vantano superfici di dimensioni medie o grandi.

A spacious wall display to deliver great performance.

Mauna is the new refrigerated display standing out for its high performance and load capacity. Particularly suitable for medium-large surfaces.

Un grand présentoir mural pour de grandes performances.

Mauna est le nouveau présentoir mural réfrigéré caractérisé par ses performances élevées et sa grande capacité de charge. Il est particulièrement adapté à des surfaces de moyennes ou de grandes dimensions.

Ein großes Wandkühlregal für große Leistung.

Mauna ist das neue gekühlte Wandregal, das sich durch seine hohe Leistung und hohe Belastbarkeit auszeichnet. Es eignet sich besonders für Räume mit mittleren oder großen Flächen.



D113 Yellow Version B-200



Width in cm.

82



Length in cm.

93,7 · 125
187,5 · 250



Climate class

B-200 e F-200: 3 M2
B-200 VIEW: 3 M1



Shelf Depth in cm.

51



Load capacity in lt.

93,7 = 692 lt.
125 = 924 lt.
187,5 = 1386 lt.
250 = 1848 lt.



D153 Magic Gold
Version
B-200 VIEW

1

Ripiani inclinabili e regolabili
in altezza.

Inclinable and height adjustable
shelves.

Étagères inclinables et réglables
en hauteur.

Möglichkeit von schräger und
höhenverstellbare Fachböden.

2

Illuminazione LED.

LED lighting.

Éclairage LED

LED-Beleuchtung

3

Zona esposizione in acciaio Inox.

Display area in stainless steel.

Zone d'exposition en acier inox.

Auslagefläche aus Edelstahl.

4

Canalizzabile.

Multiplexable.

Canalisable.

Kanalierbar.

D151 White Butter
Version
B-200 VIEW



White Oak
Version
B-200 D136

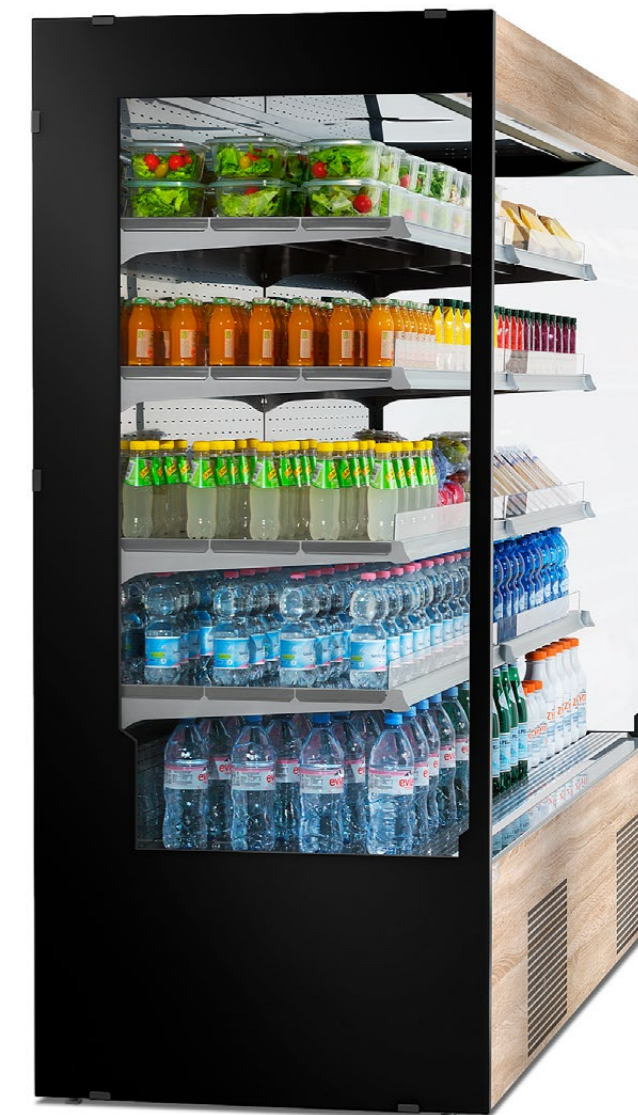

MAUNA Versions

Gray **Black** Optional

Colori spalla
End colours
Couleurs des côtés
Farben für Rückwände

Black

Colori spalle panoramiche
Panoramic sidewalls
Couleurs des côtés panoramiques
Farben für Panorama-Rückwände

B-200

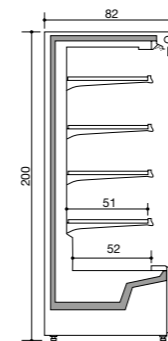

4 ripiani
4 shelves
4 étagères
4 Fachböden

B-200
View

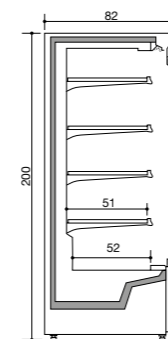

4 ripiani - porte scorrevoli
4 shelves - sliding doors
4 étagères - porte coulissantes
4 Fachböden - Schiebetüren

F-200

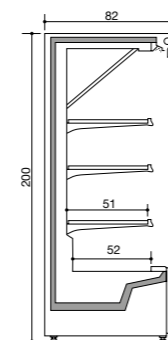

3 ripiani con specchio
3 shelves with mirror
3 étagères avec miroir
3 Fachböden mit spiegel



Need space? Here you are!

Z•IN



Width in cm.

91



Length in cm.

125 · 187,5
250 · 312,5



Climate class

3 M2
25°C / u.r. 60%



Shelf Depth in cm.

25/35



Load capacity in lt.

125 = 263 lt.
187,5 = 394 lt.
250 = 455 lt.
312,5 = 677 lt.

Estrema praticità per la vendita promozionale.

Fujiyama è stato progettato per l'esposizione e la vendita di prodotti take-away, ma è perfetto anche per ogni layout con aree promozionali di forte impatto.

È inoltre ideale per preservare tutte le proprietà e gli aromi del sushi e permette ai clienti di servirsi in totale libertà.

Utmost convenience for promotional sale.

Fujiyama has been designed to showcase and sell take away products, however, it fits perfectly in any retail surface with high-impact promotional areas. Ideal to preserve all the characteristics and flavours of sushi while enabling customers to help themselves.

Extrêmement pratique pour la vente promotionnelle.

Fujiyama a été conçu pour l'exposition et la vente de produits à emporter, mais il est également parfait pour tous les aménagements de grand impact dans des espaces promotionnels. Il est aussi idéal pour préserver toutes les propriétés et tous les arômes du sushi et permet aux clients de se servir en toute liberté.

Äußerst praktisch für Werbeverkäufe.

Der Fujiyama ist für die Ausstellung und den Verkauf von Produkten zum Mitnehmen konzipiert. Er eignet sich aber auch perfekt für alle anderen Layouts mit hochwirksamen Werbeflächen. Es ist auch ideal, um alle Eigenschaften und Aromen von Sushi zu erhalten und ermöglicht es den Kunden, sich vollkommen frei zu bedienen.



D97 Black Version B-130

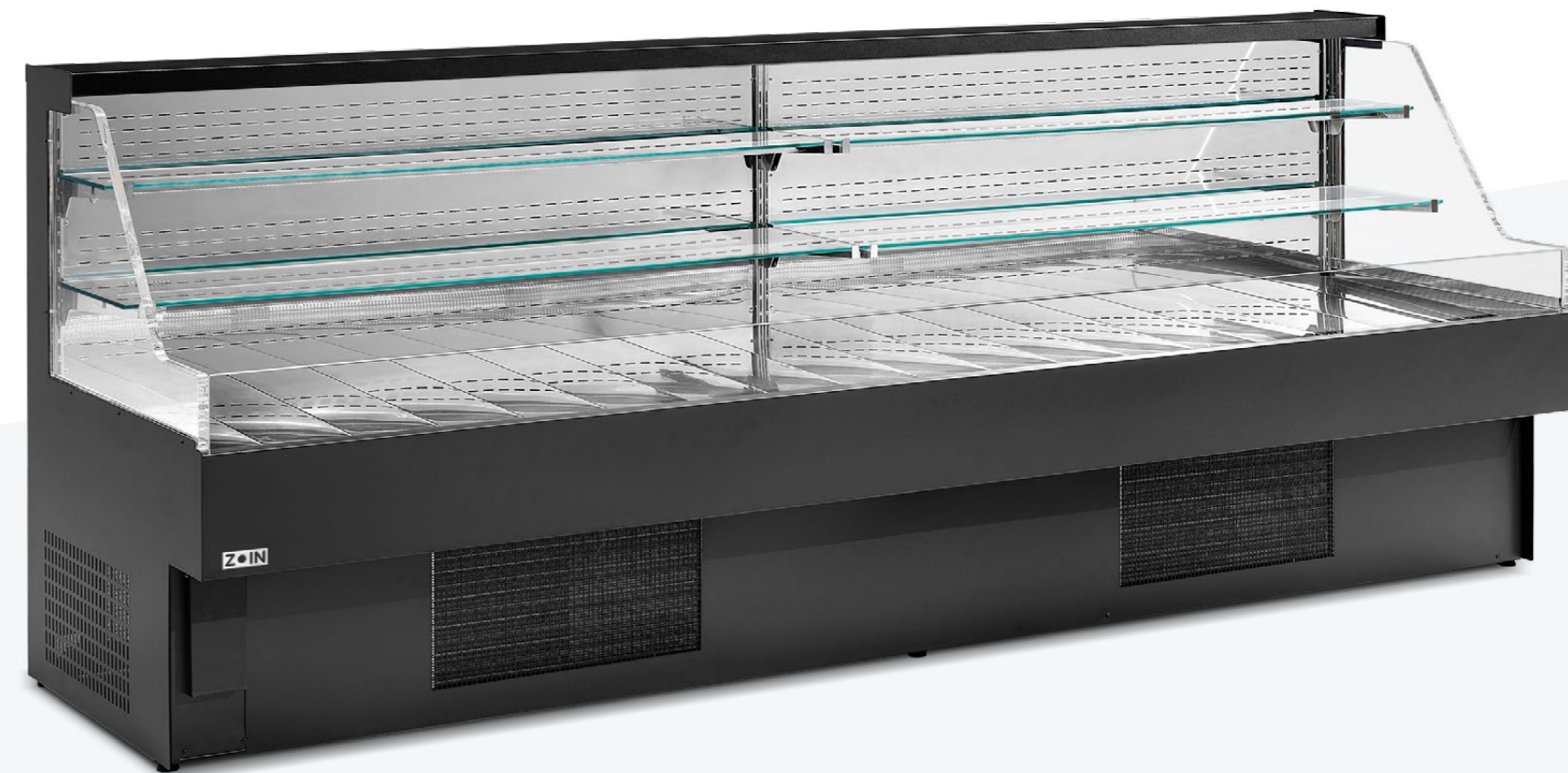

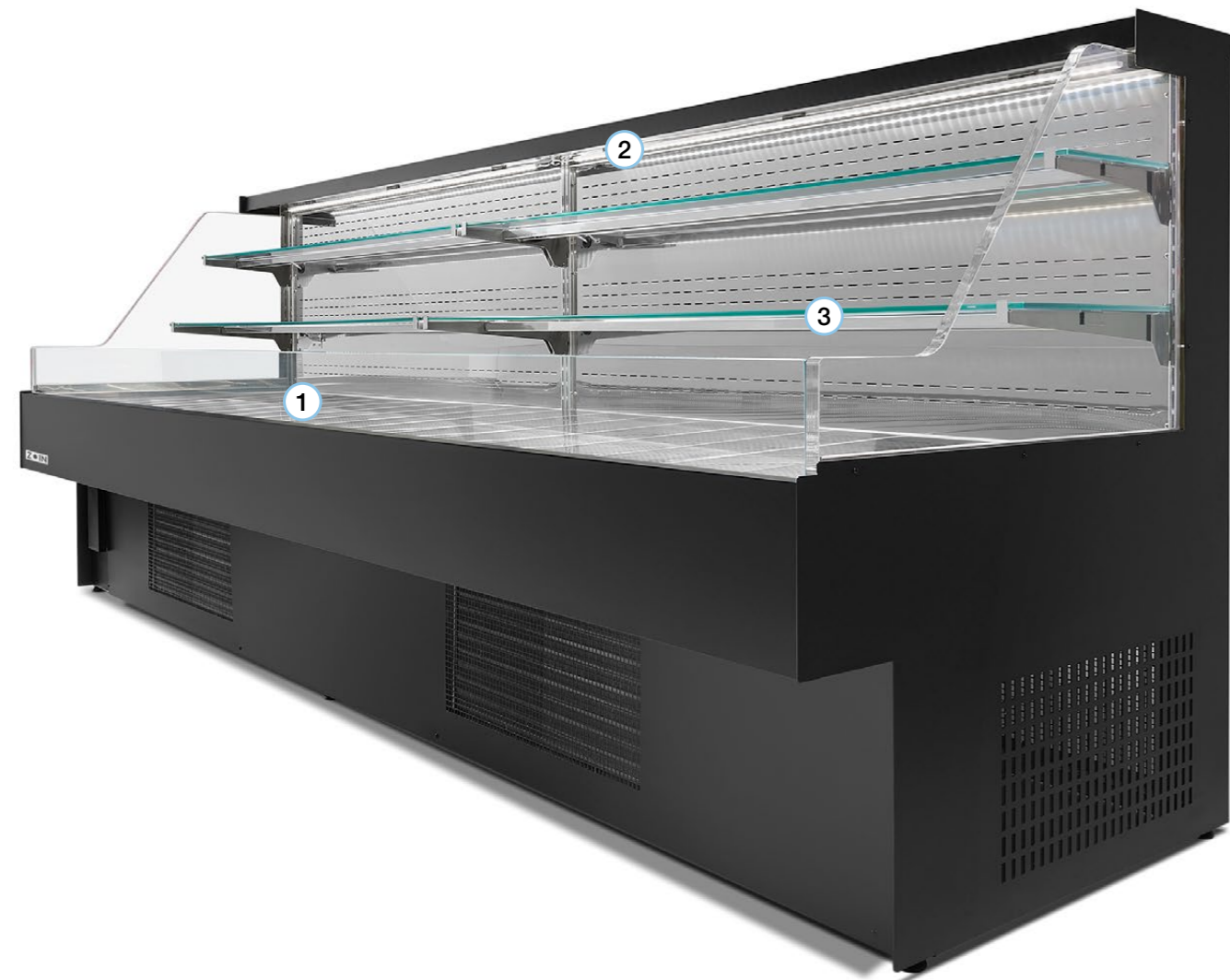

1

Zona esposizione in acciaio Inox.
Display area in stainless steel.
Zone d'exposition en acier inox.
Auslagefläche aus Edelstahl.

2

Illuminazione LED su ripiani a cappello.
LED lighting on the cap of shelves.
Éclairage LED sur les étagères
au plafond.
LED-Beleuchtung an Haubenregalen.

3

Ripiani inclinabili e regolabili
in altezza.
Inclinable and height adjustable
shelves.
Étagères inclinables et réglables
en hauteur.
Möglichkeit von schräger und
höhenverstellbare Fachböden.

FUJIYAMA Versions

Black

Colori spalla
End colours
Couleurs des côtés
Farben für Rückwände

B-130

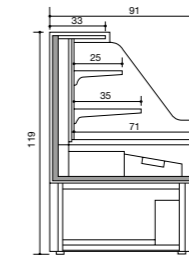

2 Ripiani
2 Shelves
2 Étagères
2 Fachböden

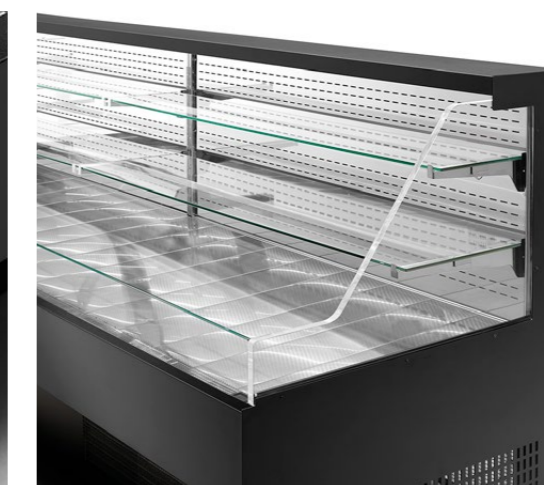



Semiverticale, totalmente efficiente.

Mandy è il murale semiverticale destinato al Self-Service e studiato per l'esposizione e la vendita di sandwich, insalate, bibite e "food to go". Si presta perfettamente a essere inserito nel layout del punto vendita per creare aree promozionali.

Semi-vertical, fully efficient.

Mandy is the semi-vertical wall display for self-service. Conceived for the display and sale of sandwiches, salads, drinks and food to go. Perfect to create promotional areas inside the retail area.

Semi-vertical, totalement efficace.

Mandy est le présentoir mural semi-vertical destiné au Self-Service et est conçu pour l'exposition et la vente de sandwiches, de salades, de boissons et de plats à emporter. Il se prête très bien pour être inséré dans un point de vente afin de créer des espaces promotionnels.

Semivertikal, äußerst effizient.

Mandy ist das semivertikale Wandregal für die Selbstbedienung und wurde für die Ausstellung und den Verkauf von Sandwiches, Salaten, Getränken und „Food to go“ entworfen. Es lässt sich perfekt in das Layout der Verkaufsstelle einfügen, um Werbebereiche zu schaffen.

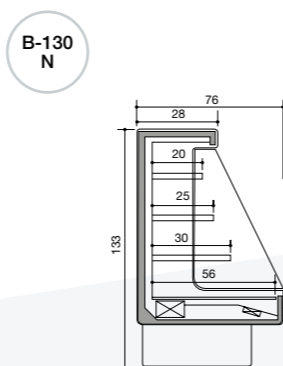

Gray **Black** Optional

Colori spalla
End colours
Couleurs des côtés
Farben für Rückwände

1

Zona esposizione in acciaio Inox.

Display area in stainless steel.

Zone d'exposition en acier inox.

Auslagefläche aus Edelstahl.

2

Ripiani inclinabili e regolabili in altezza.

Inclinable and height adjustable shelves.

Étagères inclinables et réglables en hauteur.

Möglichkeit von schräger und höhenverstellbare Fachböden.

3

Illuminazione LED su cappello.

LED lighting on cap.

Éclairage LED au plafond.

LED-Beleuchtung auf der Haube.

4

Tubo Batticarrello in acciaio Inox (Optional).

Stainless steel bumper-rail (Optional).

Moulure antichoc caddies en acier inox (Option)

Stoßstange aus Edelstahl (optional).



Width in cm.

76



Length in cm.

100 · 120
150



Climate class

3 M2
25°C / u.r. 60%



Shelf Depth in cm.

20/25/30



Load capacity in lt.

100 = 163 lt.
120 = 198 lt.
150 = 252 lt.

D97 Black Version B-130 N



Width in cm.

92



Length in cm.

129



Climate class

3 M2
25°C / u.r.60%

1

Zona esposizione verniciata nero.
Black painted display surface.
Zone d'exposition vernis noir.
Schwarz lackierte Auslagefläche.

2

Vasca raccogli condensa autoevaporante.

Drip-pan with automatic water evaporation.

Bac pour l'évaporation automatique de l'eau de dégivrage.

Kondenswassersammler mit automatischer Verdunstung.

3

Deflettore in plexiglass.

Plexiglas deflector.

Défecteur en plexiglas.

Deflektor aus Plexiglas.

S-4

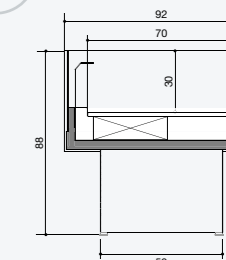

Modularità e grande flessibilità.

Con Flatey, il banco modulare che garantisce grande flessibilità nella realizzazione del layout, sarà molto facile e veloce cambiare il setting dell'area di vendita. Studiato per l'esposizione di prodotti come salumi e formaggi, frutta e verdure, take-away e bibite.

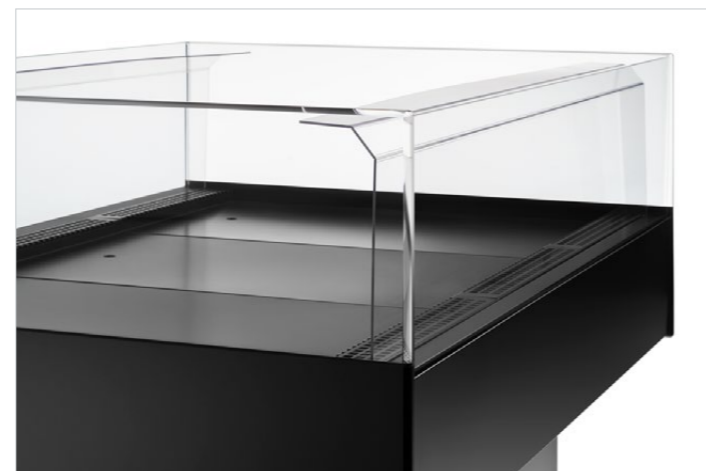

Modularity and great flexibility.

Changing the retail area will be much faster and easier thanks to Flatey: the new modular counter to change the layout with great flexibility. Ideal for products such as cold cuts and cheese, fruits and vegetables, take away dishes and drinks.

Modularité et grande flexibilité.

Avec Flatey, le comptoir modulaire qui garantit une grande flexibilité dans la réalisation de l'aménagement, il sera très facile de changer rapidement la disposition de l'espace de vente. Conçu pour l'exposition de produits comme les charcuteries et les fromages, les fruits et les légumes, les plats à emporter et les boissons.

Modulare Struktur und große Flexibilität.

Mit Flatey, der modularen Theke, die eine große Flexibilität bei der Umsetzung des Layouts garantiert, ist es sehr einfach und schnell möglich, die Gestaltung des Verkaufsraums zu verändern. Entwickelt, um Produkte wie Aufschnitt und Käse, Obst und Gemüse, Take-away und Erfrischungsgetränke auszustellen.

D116 Gray Version S-4

Gray Black Optional

Colori spalla
End colours
Couleurs des côtés
Farben für Rückwände

SERVE-OVER

A		VETRO CURVO APRIBILE VERSO L'ALTO
B		VETRO DRITTO APRIBILE A COMPASSO
C		VETRO RETTO APRIBILE A COMPASSO
D		VETRO RETTO APRIBILE VERSO L'ALTO
Y		VETRO CURVO APRIBILE A COMPASSO
S		VETRO SELF SERVICE

1	STATICO CON CELLA
2	VENTILATO CON CELLA
3	STATICO SENZA CELLA
4	VENTILATO SENZA CELLA
5	CALDO
6	NON REFRIGERATO
7	CON SUPPORTO E RUOTE
8	SENZA SUPPORTO E RUOTE
FISH	VERSIONE PER PESCE

A		CURVED GLASS OPENING UPWARDS
B		STRIGHT GLASS OPENING DOWNWARDS
C		VERTICAL GLASS OPENING DOWNWARDS
D		STRIGHT GLASS OPENING UPWARDS
Y		CURVED GLASS OPENING DOWNWARDS
S		GLASS SELF SERVICE

1	STATIC WITH COOL STORAGE
2	STATIC WITH COOL STORAGE
3	STATIC WITHOUT COOL STORAGE
4	VENTILATED WITHOUT COOL STORAGE
5	HOT-SECTION
6	NOT REFRIGERATED
7	WITH SUPPORT AND CASTORS
8	WITHOUT SUPPORT AND CASTORS
FISH	FISH VERSION

A	SPALLE A "BLOCCHI"
B	RIPIANI INCLINABILI CREMAGLIERE
F	FRUTTA VERDURA CREMAGLIERE+ SPECCHIO
SG	SENZA GRUPPO INCORPORATO
FG	SENZA GRUPPO INCORPORATO FRUTTA VERDURA
VIEW	MURALI CON PORTE A VETRI SCORREVOLI

130	H MURALE CIRCA 130 CM.
130N	H MURALE CIRCA 130 CM. BATTICARRELLO PLASTICA
130L	H MURALE CIRCA 130 CM. BATTICARRELLO INOX VETRINO FRONTALE
160	H MURALE CIRCA 160 CM.
180	H MURALE CIRCA 180 CM.
190	H MURALE CIRCA 190 CM.
200	H MURALE CIRCA 200 CM.
B20 B30	RETROBANCO CON BASAMENTO
P20 P30	RETROBANCO PENSILE DA APPENDERE O APPOGGIARE

SELF SERVICE DISPLAY

A	ENDWALLS WITH BLOCKS
B	INCLINABLE SHELVES WITH RACK
F	FRIUT & VEGETABLES WITH RACK AND MIRROR
SG	WITHOUT BUILT UNIT
FG	WITHOUT BUILT UNIT FRIUT & VEGETABLES
VIEW	REFRIGERATED WALL CABINET WITH SLIDING DOORS

130	REF. WALL CABINET APROX H 130 CM.
130N	REF. WALL CABINET APROX H 130 CM. PLASTIC BUMPER
130L	REF. WALL CABINET APROX H 130 CM. INOX BUMPER & FRONT GLASS
160	REF. WALL CABINET APROX H 180 CM. PLASTIC BUMPER
180	REF. WALL CABINET APROX H 180 CM. PLASTIC BUMPER
190	REF. WALL CABINET APROX H 190 CM.
200	REF. WALL CABINET APROX H 200 CM.
B20 B30	BACK-COUNTER WITH LOWER STRUCTURE
P20 P30	BACK-COUNTER FOR HANGING OR PLACING ON LOWER STRUCTURE

COLORI

Colori disponibili
Available colors
Couleurs disponibles
Verfügbare Farben

Batticarrello
Bumpers
Pare-chocs
Stoßfänger

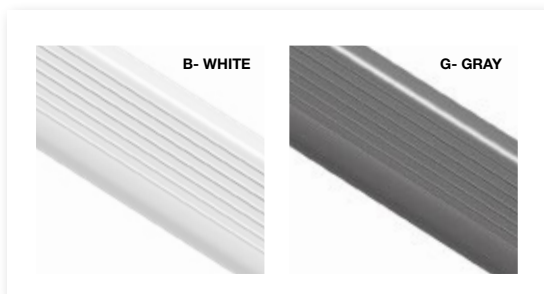
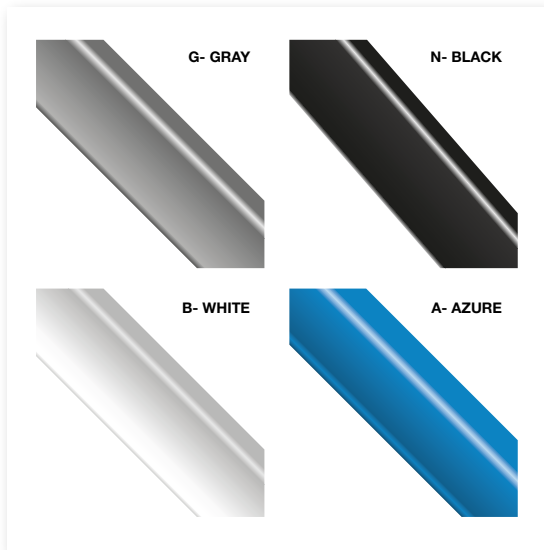
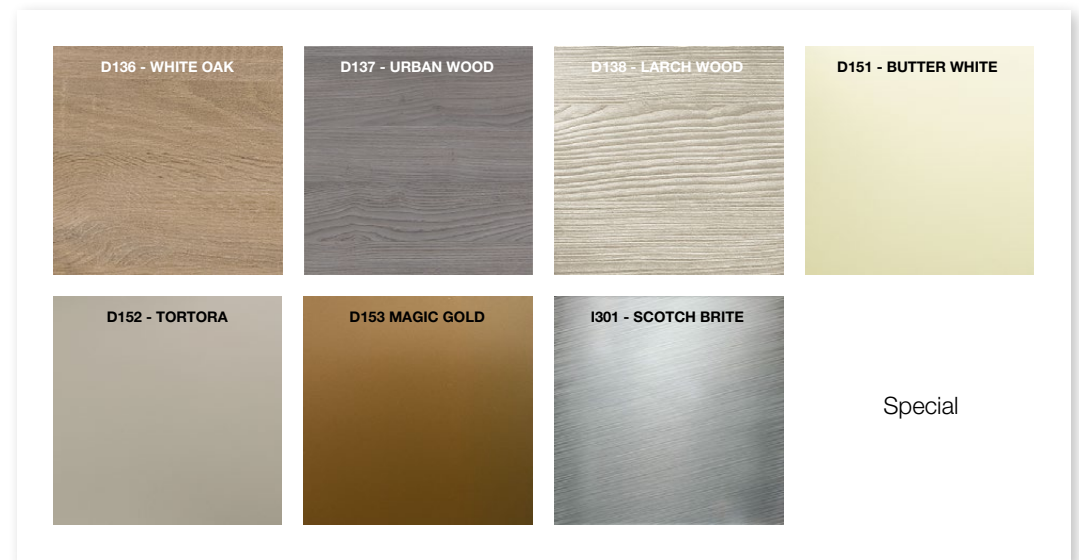
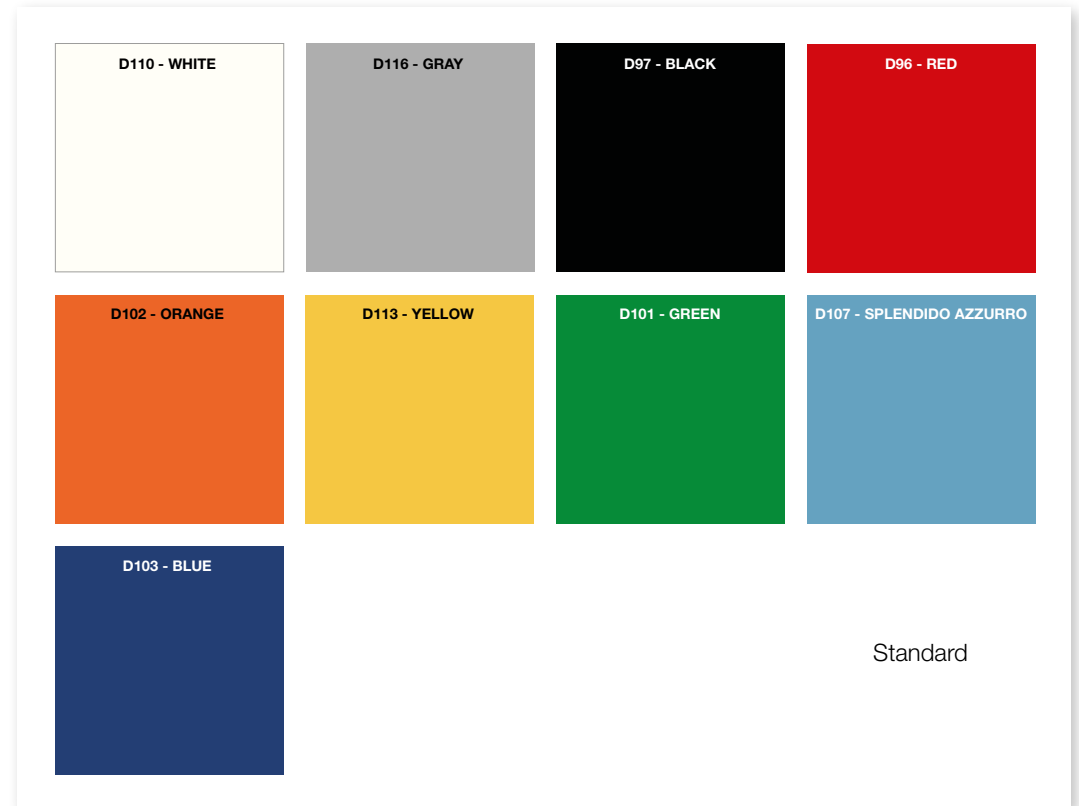



GLOBAL COOLING

ZOIN Srl

Via Roma n. 320/1,
35030, CERVARESE SANTA CROCE (PD) - ITALY
Tel. (+39) 049 907 0172
www.zoin.it zoin@zoin.it